

REV	Revision History	Drawing/Date	Audit/Date
	New Issue	Zhiwei Xu/09/03/2016	

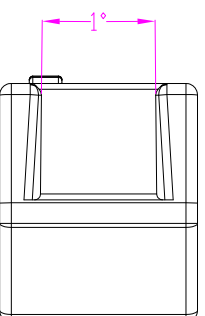
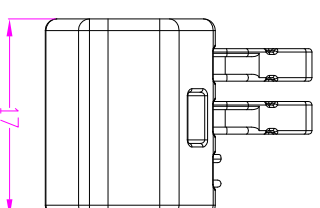
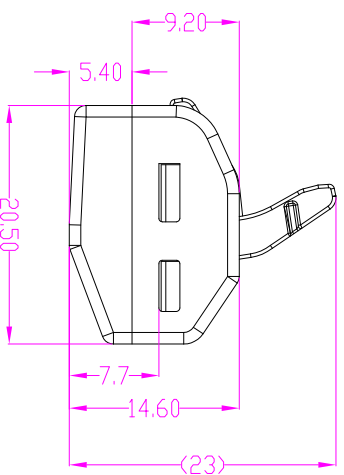
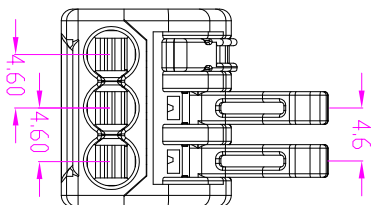
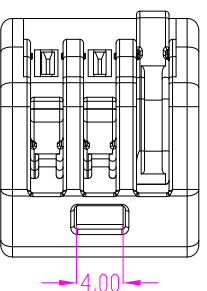
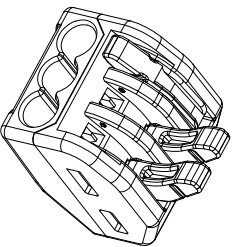
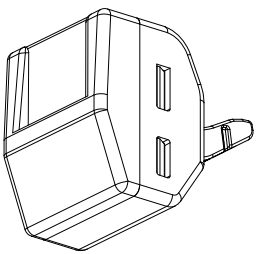

Material Parameters:

Plastic Part: PA66 UL94V-0
 Hardware: Stainless Steel
 Phosphor Bronze
 Tin Plating

Parameter

Rated Voltage: 400V/600V
 Rated Impulse Voltage: 32A/20A
 Trim Length: 9-10mm

Without individual tolerance reference	Drawing Categories	Product Diagram	Part No.	*****
0.5~3	Dimension Limits	m m	Drawing No.	---
±0.08	3~6	⊕	Scale	1:1
	6~30	⊖	Page	A4
	30~120			
	>120			
	Projection Method			

Item No. **CM-222-3P**

Type **Wire Connector**

